

DIN rail mounting dual loop controller/analogue acquisition module delta**due**[®] series **D2 line**

Two loops in the space of one

A common bus for serial power supply and communications, total withdrawability, ease of replacement even with the power supply on, digital inputs for remote commands, the option of acquiring or controlling two analogue variables makes the delta**due**[®] D2 line a powerful and flexible instrument, suitable for solving the most diverse problems of field signal management. Together with the DX module, it can be used in PROFIBUS DP[®] and DeviceNet[®] networks, with the automatic reconfiguration option (hot swapping).

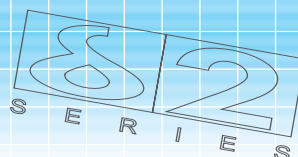
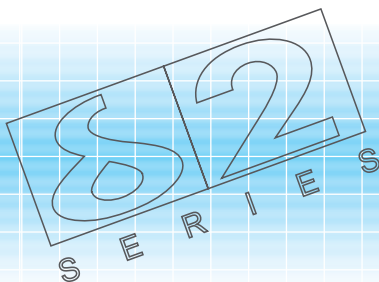
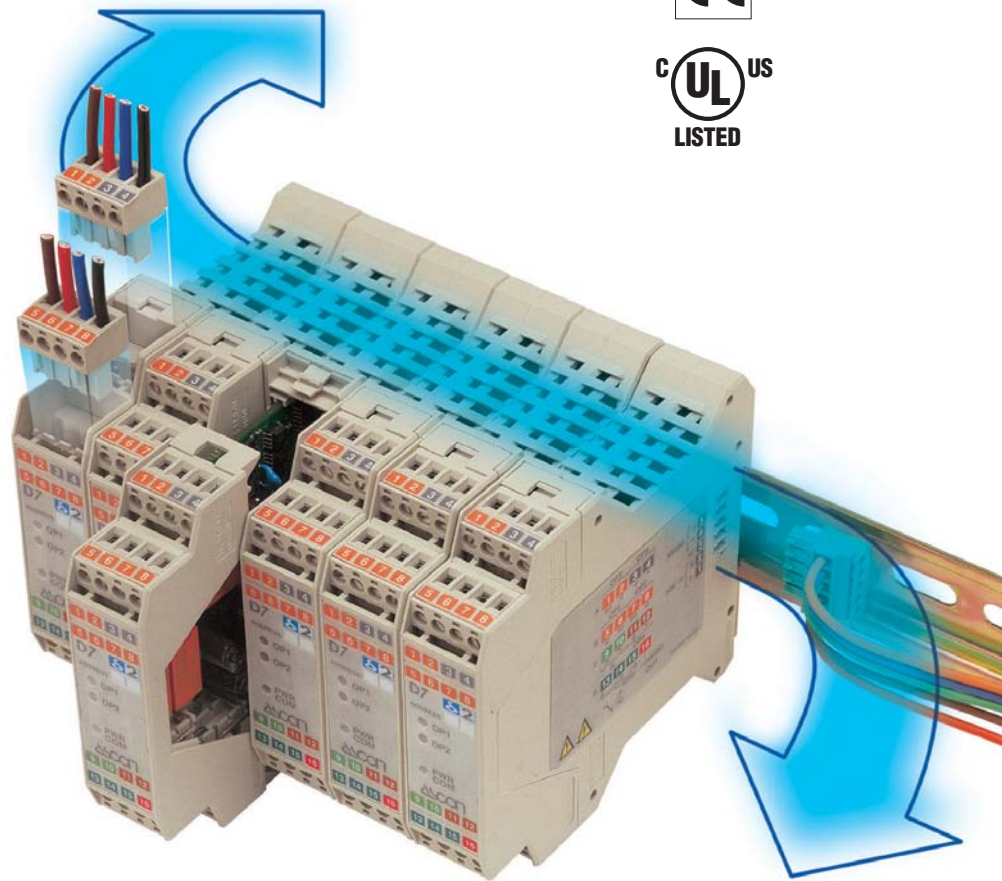

ISO 9001 certified

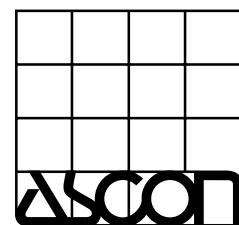

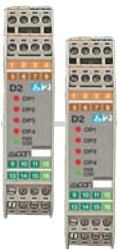

Advantages and peculiarities

Keeping costs low



Modular construction and compact dimensions:

- Quick mounting on DIN rail;
- Possibility of prewiring;
- Common bus for power supply and serial communications.

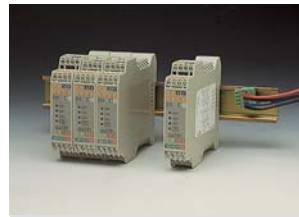

- Polarised connectors;
- Coloured Terminal identification.



High integration

- On-machine or rear panel mounting
- Remote/centralised control;
- RS485/CanBus;
- PROFIBUS DP, DeviceNet (with DX module).



- Withdrawable;
- Easy replacement without switching off the power supply;
- Hot swapping, automatic configuration of the new or replaced modules (with DX module).

Easy maintenance

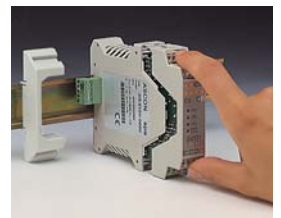

Typical applications

Local control with operator panel OP30

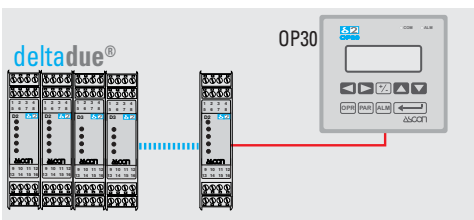

Distributed control with PLC with dedicated modules for critical loops

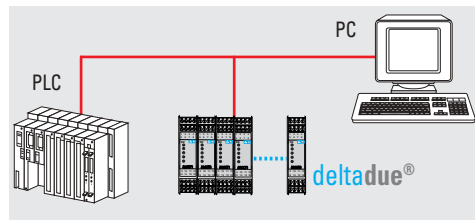

Distributed control with PC supervision

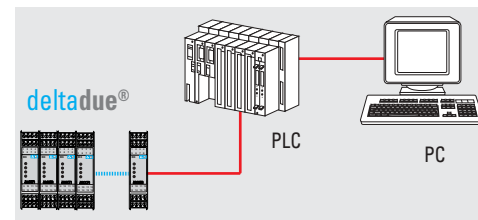

Resources

Main universal inputs

12 TC, Pt100, ΔT, mA, V, Custom → PV1

12 TC, Pt100, ΔT, mA, V, Custom → PV2

Digital input for external commands

→ IL1

D2

Digital outputs [1]

OP1, OP2, OP3, OP4

Digital inputs [2]

- Setpoint**
- LOC
 - 2+2 MEM
- IL1 connected functions**
- HOLD PV
 - ACK ALM

Modbus RS485
Parameterisation
Supervision

- Available functions**
- Not

- Fuzzy tuning with automatic selection**
- One shot Auto tuning
 - One shot Natural Frequency

Operating modes

		Control	Alarms	
PV1	0 Acquisition only		OP1	OP3
	1 Single action		OP1	OP3
	2 Single action		OP3	OP1
PV2	3 Acquisition only		OP2	OP4
	4 Single action		OP2	OP4
	5 Single action		OP4	OP2
PV1	6 Single action	OP1	OP2	OP3
PV2	7 Single action	OP4		

Notes: 1. Each output (OP1...OP4) can freely be associated with one of the two inputs (PV1 or PV2).
2. When outputs OP3 and OP4 are not used as such, they can be used as voltage free or voltage inputs.

Technical data

Features at env. 25°C	Description			
Total configurability	By means of the configuration tool it is possible to select: - type of input - the type of control input - type of output - type and functionality of the alarms - type of Setpoint - control parameter values			
PV1 and PV2 inputs	Common characteristics	A/D converter with resolution of 50,000 points Update measurement time: 0.2 s Sampling time: 0.5 s Input bias: -60...+60 digit Input filter: 1...30 s OFF = 0		
	Accuracy	0.25% ±1 digit (for temperature sensor) 0.1% ±1 digit (for mA and mV)	Between 100...240Vac the error is minimal	
	Resistance thermometer (for ΔT: R1+R2 dmust be <320Ω)	Pt100Ω at 0°C (IEC 751) °C/°F selectable	2 or 3 wires connection Burnout (with any combination)	Line: 20Ω max. (3 wires) Input drift: 0.35°C/10°C Env. Temp. <0.35°C/10Ω Wire Res.
	Thermocouple	L, J, T, K, S, R, B, N, E, W3, W5 (IEC 584) °C/°F selectable	Internal cold junction compensation with NTC Error 1...20°C ±0,5°C Burnout	Line 150Ω max. Input drift <2μV/1°C Env. Temp. <5μV/10Ω Wire Res.
	DC input (current)	0/4...20mA, 2.5Ω ext. shunt Rj >10MΩ	Burnout. Engineering inputs, decimal point position configurable low range: -999...9999 high range: -999...9999 (min. range: 100 digits)	Input drift: <0.1%/20°C Env. Temp. <5μV/10Ω Wire Res.
	DC input (voltage)	10...50mV, 0...50mV Rj >10MΩ		
	Mutual isolation	Isolation voltage 500V		
Digital input	Closing the external contact allows:	Auto/Man mode change, switching between 2 stored setpoints, measure hold, alarms acknowledge, outputs lock		
Operating mode	2 acquisition channels, 2 single action loops PID or ON/OFF with 1, 2, 3 or 4 alarms			
Control mode	Algorithm	PID with overshoot control or ON/ OFF		
	Proportional band (P)	0.5...999.9%		
	Integral time (I)	0.1...100.0 min	OFF = 0	
	Derivative time (D)	0.01...10.00 min		
	Error dead band	0.1...10.0 digit		
	Overshoot control	0.01...1.00		
	Manual reset	0.0...100.0%		
	Cycle time (time proportional only)	1...200s		
	Control output high limit	10.0...100.0%		
	Control output low limit	0.0...90.0%		
Soft start output value	0.1...100.0%	OFF = 0		
Control output hysteresis	0.1...10.0%	ON/OFF algorithm		
OP1-OP2 outputs	SPST relay NO, 2A/250Vac (4A/110 Vac) for resistive load SSR, 1A/250Vac for resistive load SSR drive: 0/5Vdc, ±10% 30 mA max. To meet the double isolation requirements, OP1 and OP2 must have the same load type			
OP3-OP4 outputs	Non isolated logic: 0/5Vdc, ±10% 30 mA max.			
Outputs functions	For all the outputs the inversion function (NOT) is available			
AL1 - AL2 - AL3 - AL4 alarms	Hysteresis	0.1...10.0%		
	Action	Active high	Action type	
		Active low		
		Special functions	Sensor break, Loop break Alarm acknowledge (latching), activation inhibit (blocking)	
	Alarm source	Assigns the alarms to the Present Value of LOOP 1/LOOP 2 (PV1 or PV2). If set as deviation or band, the alarms are assigned to the Setpoint of LOOP 1 or LOOP 2		
Alarm output	Assigns the alarm condition to an output (OP1, OP2, OP3, OP4). If not configured, the alarm status is available on the coil			
Setpoint (for each loop)	Local	Up and down ramps 0.1...999.9 digit/min. (OFF=0)		
	Local + 2 stored	Low limit: from low range to high limit High limit: from low limit to high range		
Fuzzy-Tuning one shot (1 loop at a time)	The controller automatically selects the best method according to the process conditions		One shot Auto Tuning	
			One shot Natural Frequency	

Fuzzy-Tuning

Two methods of tuning are available:

- **Auto-Tuning "one shot"**
- **Natural frequency "one shot"**

The **Fuzzy-Tuning** automatically selects one of the two methods which assures the best result for each condition.

Auto-Tuning method best works on the step response basis.

When activated, if a deviation exists between the Setpoint and process variable larger than 5% of scale range, the controller modifies the output value. Then, in a short time, it calculates the PID parameters and the new algorithm is operational immediately.

The main advantages of this method are fast calculation and quick implementation.

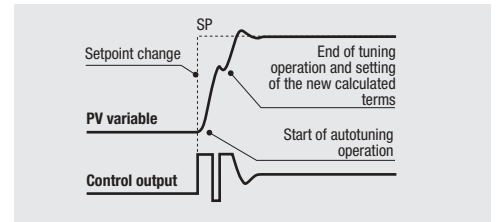

The **Natural frequency** method best works when the process variable is very near to the Setpoint. When activated, it causes a process oscillation around the Setpoint value in order to calculate the optimal PID parameters.

The main advantage of this method is the better definition of PID parameters.

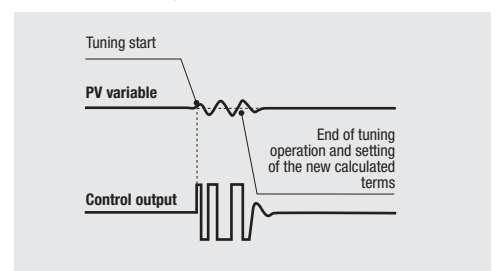

Technical data

Features at 25°C Env. Temp.	Description		
Auto/Man station	Standard with bumpless function, Switched by digital input or serial communications		
Serial communications	RS 485 isolated, Modbus/Jbus RTU protocol, 1,200, 2,400, 4,800, 9,600 bit/s 2 wires		
Operational safety	Measure input	Detection of out of range, or input problems causes automatic activation of the safety strategies	
	Control output	Safety value: -100...100%	
	Parameters	Parameters and configuration data are stored in a non volatile memory for an unlimited time	
	Outputs lock		
General characteristics	Power supply (PTC protected)	24Vac (-20...+12%) 50/60Hz and 24Vdc (-15...+25%)	Power consumption 3 W max.
	Safety	EN61010-1 (IEC1010-1) installation class 2 (2.5kV), pollution class 2, instrument class II	
	Electromagnetic compatibility	Compliance to the CE standards	
	UL and cUL approval	File E176452	
	Protection	Terminal blocks IP20	
	Dimensions	Pitch: 22.5 mm - height: 99 mm - depth 114.5 mm	
	Weight	156 g approx.	

Alarms

Four thresholds can be addressed to the four outputs. For each alarm can be configured:

A - Alarm source

Each alarm can be associated to one of the input loops. If configured as absolute alarm the threshold is compared with the present value of the selected loop (PV1 or PV2). If configured as deviation or band alarm, the threshold is compared with the selected loop Setpoint (SP1 or SP2).

B - Alarm type and function

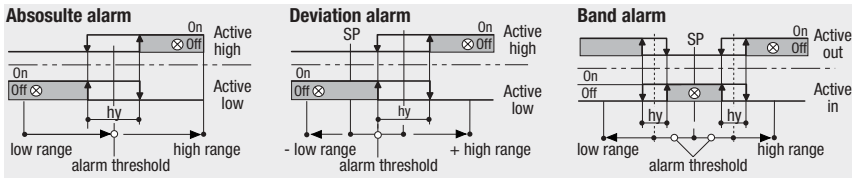

C/D - Alarm acknowledge and Start-up disable

Alarm acknowledge and disabling function for AL1, AL2, AL3 and AL4 alarms

For each threshold can be configured, using the correct parameter value: none, alarm acknowledge, start-up disable or both active (aknowledge + start-up disable).

Alarm acknowledge

The alarm status remains until the acknowledge signal arrives through the serial communications port or the digital input. After this operation alarm status disappears only when the alarm condition is no longer present.

Start-up disabling

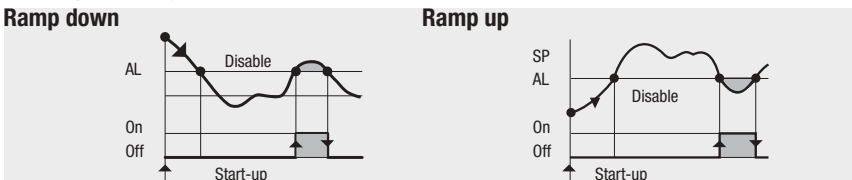

E - "Loop Break Alarm" (LBA) or sensor break functions

LBA operation delay

Set "None" to obtain an immediate action to a sensor break detection.

Set a value between 1...9999 s to obtain a delayed action to a loop break detection.

Also with the LBA operation delay set, if the error detected is caused by a sensor break, the action is immediate. When the cause of the alarm disappears, the alarm status stops.

F - Alarm output

Physical output of the alarm

When not used as control outputs, one or more alarms (OR function) can be linked to OP1/OP2/OP3/OP4. This parameter can be set as: Coil (internal status), OP1, OP2, OP3, OP4.

Digital input

During the configuration procedure, to the IL digital input can be connected one of the following functions:

- Measure Hold: PV1, PV2 or PV1 and PV2
- Auto/Man mode change: PV1, PV2 or PV1 and PV2
- Recall of the 2nd stored Setpoint: 1° setpoint LOOP 1, 1° setpoint LOOP 2 or 2° setpoint LOOP 1 and LOOP 2.
- Alarm acknowledge;
- Outputs block.

Output functions

Is possible to enable, separately for each output (OP1...OP4), the negate (NOT) function of the internal status.

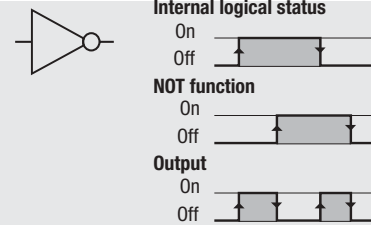

Electrical connections

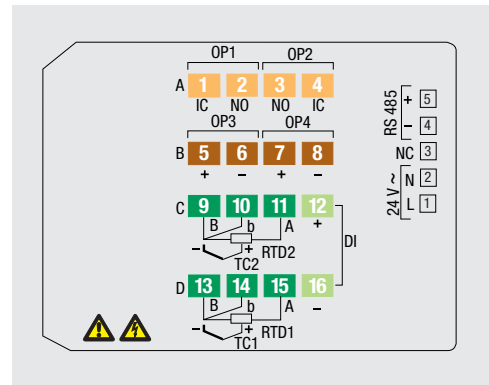

Ordering codes

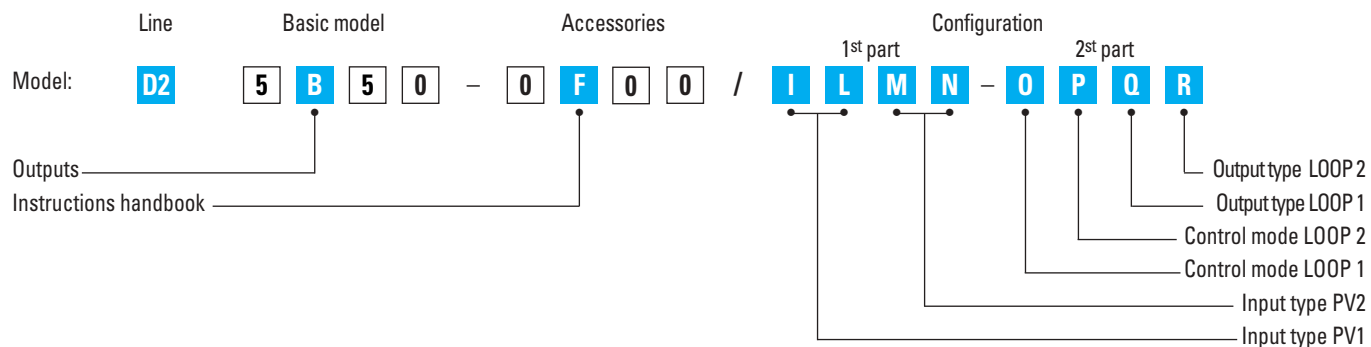

OP1 and OP2 Outputs	B
Relay/Relay	1
Relay/SSR drive	2
SSR drive/SSR drive	3
SSR/SSR	4
SSR/SSR drive	5
Instructions handbook	F
Italian-English (standard)	0
French-English	1
German-English	2
Spanish-English	3

Input type	Range scale		PV1	I	L
	Range scale		PV2	M	N
TR Pt100 IEC751	-99.9...300.0 °C	-99.9...572.0 °F	0	0	0
TR Pt100 IEC751	-200...600 °C	-328...1112 °F	0	1	1
TC L Fe-Const. DIN43710	0...600 °C	32...1112 °F	0	2	2
TC J Fe-Cu45% Ni IEC584	0...600 °C	32...1112 °F	0	3	3
TC T Cu-CuNi	-200...400 °C	-328...752 °F	0	4	4
TC K Chromel -Alumel IEC584	0...1200 °C	32...2192 °F	0	5	5
TC S Pt10%Rh-Pt IEC584	0...1600 °C	32...2912 °F	0	6	6
TC R Pt13%Rh-Pt IEC584	0...1600 °C	32...2912 °F	0	7	7
TC B Pt30%Rh-Pt Pt6%Rh IEC584	0...1800 °C	32...3272 °F	0	8	8
TC N Nichrosil-Nisil IEC584	0...1200 °C	32...2192 °F	0	9	9
TC E Ni10%Cr-CuNi IEC584	0...600 °C	32...1112 °F	1	0	0
TC Ni-NiMo 18%	0...1100 °C	32...2012 °F	1	1	1
TC W3%Re-W25%Re	0...2000 °C	32...3632 °F	1	2	2
TC W5%Re-W26%Re	0...2000 °C	32...3632 °F	1	3	3
0...50mV linear	Engineering units		1	4	4
10...50mV linear	Engineering units		1	5	5
mV "Custom" scale	On request		1	6	6

Action type	LOOP 1	0
Action type	LOOP 2	P
ON/OFF reverse action		0
ON/OFF direct action		1
PID reverse single action		2
PID direct single action		3

Control output type	LOOP 1	Q
None		0
OP1		1
OP3		2

Control output type	LOOP 2	R
None		0
OP2		1
OP4		2

Installation kit

Each set of interconnected controllers requires one model **AD3-KIT/BA.RT.PC.CD** kit:

Power supply and serial communications connector
code AD3/BA



Couple of connector protections
code AD3/PC



Connector with termination resistor for serial communications
code AD3/RT



CD Rom with configuration software tool
code AD3/CD



**If not differently specified the controller will be supplied with standard version
Model: D2 5350-0000**

DX line - Manager Gateway

ASCON spa
Via Falzarego, 9/11
20021 Baranzate
(Milano) Italy
Tel. +39 02 333 371
Fax +39 02 350 4243
<http://www.ascon.it>
sales@ascon.it

ASCON FRANCE
2 bis, Rue Paul Henri Spaak
ST.THIBAUT DES VIGNES
F-77462 LAGNY SUR MARNE -
Cedex
Tél. +33 (0) 1 64 30 62 62
Fax +33 (0) 1 64 30 84 98
www.ascon.fr
ascon.france@ascon.fr

AGENCE EST
Tél. +33 (3) 89 76 99 89
Fax +33 (3) 89 76 87 03

ASCON CORPORATION
1884 East Fabyan Parkway
Batavia, Illinois 60510
Tel. +1 630 482 2950
Fax +1 630 482 2956
www.asconcorp.com
info@asconcorp.com

WORLDWIDE NETWORK OF DIRECT SALES CENTRES, DISTRIBUTORS AND VARs

Europe

Belgium, Croatia, Czech Rep., Denmark, Esthonia, Finland, France, Germany, Great Britain, Greece, Holland, Ireland, Norway, Poland, Portugal, Romania, Russia, Slovakia, Slovenia, Spain, Sweden, Switzerland, Turkey, Ukraine

Americas

Argentina, Brazil, Canada, Chile, Colombia, Ecuador, Paraguay, Peru, Uruguay, Venezuela

Rest of the world

Algeria, Australia, China, Egypt, Hong Kong, India, Indonesia, Iran, Israel, Malaysia, Marocco, New Zeland, Pakistan, Saudi Arabia, Singapore, Taiwan, Thailand, Tunisia, South Africa & South East Africa, UAE

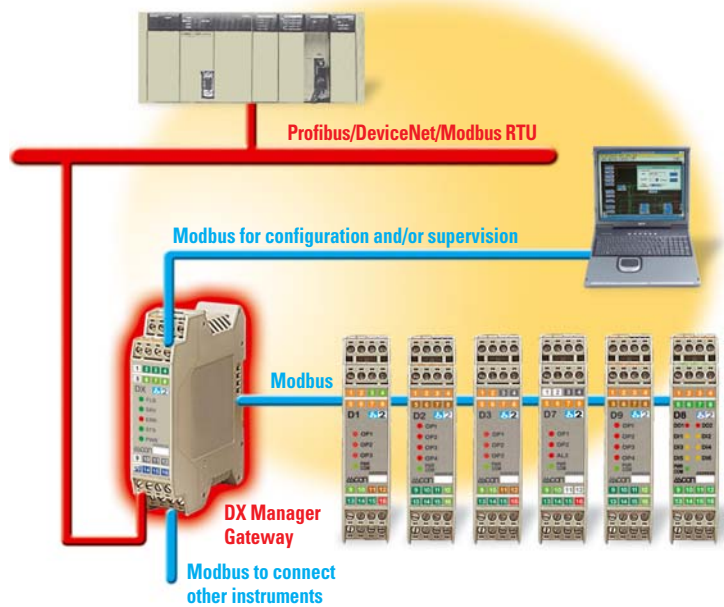

Electrical connections

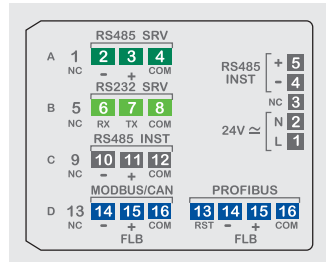

Ordering codes

Line Basic model Accessories Configuration

Model: **DX** **5** **B** **C** **0** - **0** **F** **0** **0** / **0** **0** **0** **0**

No. of instruments backed up Instructions handbook

Fieldbus communications

Number of instruments to be backed up	B
0	0
4	1
8	2
16	3
32	4

Fieldbus communications	C
None	0
Devicenet	1
RS 485 Modbus/Jbus RTU	5
Profibus DP slave	7

Instructions handbook	F
Italian-English (standard)	0
French-English	1
German-English	2
Spanish-English	3

If not differently specified the instrument will be supplied with standard version
Model: DX 5000-0000

Note: the instrument executes the RS232/485 converter hardware function only for the Modbus RTU protocol.

Technical data

Features at env. 25°C	Description	
Functions	Manager	OFF line configuration and parameterization. Backup of the configuration and parameter data of the connected modules. Hot swapping, automatic configuration and parameterization of the replaced modules
	Gateway	Network adapter for Profibus DP, DeviceNet, Modbus RTU and RS485/RS232 converter
Communications ports	Instruments Bus	RS485 Modbus protocol master replicated on the terminal connectors (max. 19200 baud)
	Support	RS485, RS232 Modbus RTU protocol slave, isolated (max. 38400 baud)
		RS485 Modbus RTU protocol slave, isolated (max. 57600 baud)
		Fieldbus
General characteristics	See the entry "General characteristics" of the other module for details	DP control: SPC3
		DP interface: RS485 isolated, max. 12 Mb/s
		CAN 2.0b, isolated, max. 1Mb/s (for DeviceNet)